

Speciation on the Azores islands: congruent patterns in shell morphology, genital anatomy, and molecular markers in endemic land snails (Gastropoda, Leptaxinae)

KURT JORDAENS^{1*}, PATRICK VAN RIEL^{1,3}, ANTONIO M. FRIAS MARTINS² and THIERRY BACKELJAU^{1,3}

¹Department of Biology, University of Antwerp, Groenenborgerlaan 171, B-2020 Antwerp, Belgium

²Departamento de Biologia, Universidade dos Açores, Rua de Mãe de Deus, 9501-801 Ponta Delgada, São Miguel, Açores, Portugal

³Royal Belgian Institute of Natural Sciences, Vautierstraat 29, B-1000 Brussels, Belgium

Received 10 October 2008; accepted for publication 14 October 2008

Morphological data, in combination with molecular data, may provide invaluable insights into speciation processes on archipelagos. Land snails offer ample opportunities to evaluate adaptive and non-adaptive speciation scenarios. However, studies investigating processes of differentiation and speciation on the Azores are scarce. The present study comprises a morphometrical analysis of shell and genital characters in a group of Azorean land snails (Pulmonata, Leptaxinae). Geographical isolation appears to be an important mechanism underlying morphological and molecular differentiation in the Azorean Leptaxini, instead of adaptive radiation through ecological differentiation. Nevertheless, we could not exclude the occurrence of ecological speciation on the oldest island (Santa Maria) where two species that markedly differ in shell-shape co-occur. © 2009 The Linnean Society of London, *Biological Journal of the Linnean Society*, 2009, 97, 166–176.

ADDITIONAL KEYWORDS: colonization – endemism – Hygromiidae – island biogeography – Macaronesia – morphometry – multivariate analyses – radiation – reproductive organs.

INTRODUCTION

Morphological radiations on oceanic islands can be attributed to several factors that are either adaptive or non-adaptive. Non-adaptive scenarios involve the colonization of islands followed by sufficient isolation that prevents gene flow, and strong genetic drift that leads to genetic differentiation among populations and, eventually, to reproductive isolation. Adaptive scenarios assume a major role of selective pressures that are related to environmental and ecological conditions or of interactions among competing species whereby morphological or ecological character shifts occur.

The Azorean archipelago (36°55'–39°43'N; 25°00'–31°17'W) comprises nine main islands aligned on a north-west–south-east axis (Fig. 1; Table 1). The islands are of volcanic origin and vary in age from 0.3 Myr BP to 8–12 Myr BP (Johnson *et al.*, 1998) (Table 1). Volcanic activity has changed the geomorphology of the islands, especially that of São Miguel by producing a land bridge between an older eastern island (4 Myr) and a younger western island (0.55 Myr), approximately 0.05 Myr ago (Fig. 1).

Land snails represent an important portion of the endemic Azorean fauna, with 50 out of 101 species being endemic to the archipelago (Backhuys, 1975). A case in point are the Azorean Leptaxini that are classified into two genera: *Leptaxis* Lowe, 1852 with six nominal (sub)specific taxa and the monotypic genus *Helixena* Backhuys, 1975. *Leptaxis erubescens*

*Corresponding author. E-mail: kurt.jordaens@ua.ac.be

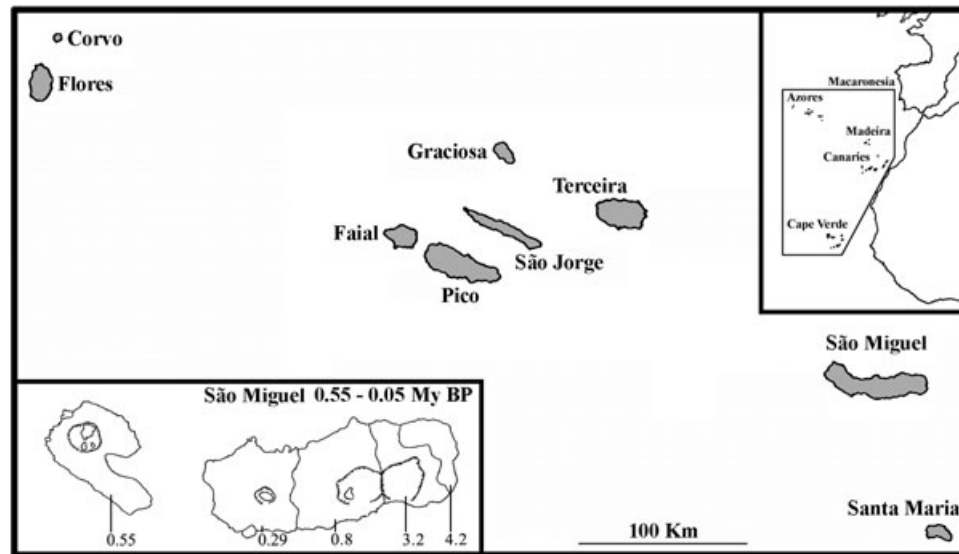

Figure 1. Map of Macaronesia, the Azores and São Miguel. The geological ages (Myr) of the different volcanic complexes of São Miguel are shown.

Table 1. Taxonomy and distribution of the Azorean Leptaxini

Species	Island (Myr)	OTU	N_{pops}	N_{shell}	N_{gt}
<i>Helixena sanctaemariae</i> (Morelet and Drouët, 1857)	Santa Maria (8)	Hs (H)	13	160	46
<i>Leptaxis azorica minor</i> (Backhuys, 1975)	Santa Maria (8)	Lam (A)	2	26	26
<i>Leptaxis azorica azorica</i> (Albers, 1852)	Eastern São Miguel (4)	Lae (A)	7	40	45
	Western São Miguel (0.55)	Law (A)	5	44	36
	Flores (2)	Laf (A)	2	21	20
<i>Leptaxis caldeirarum</i> (Morelet and Drouët, 1857)	Western São Miguel (0.55)	Lc (C)	2	31	30
<i>Leptaxis terceirana</i> (Morelet, 1860)	Terceira (2)	Lt (C)	1	63	14
<i>Leptaxis</i> sp. from Graciosa	Graciosa (0.62)	Lg (C)	1	5	3
<i>Leptaxis drouetiana</i> (Morelet, 1860)	Faial (0.8)	Ld (C)	1	22	3
<i>Leptaxis</i> sp. from Pico	Pico (0.3)	Lp (C)	1	7	5

The geological age of the islands is given in parentheses (Myr), operational taxonomic unit (OTU) and shell-type (in parentheses) (H, *Helixena* shell-type; A, *azorica* shell-type; C, *caldeirarum* shell-type), number of populations (N_{pops}) studied, number of specimens used for the morphometrical analysis of the shell (N_{shell}) and the genital tract (N_{gt}).

(Lowe, 1831) was probably introduced by man from Madeira (Backhuys, 1975) and does not appear to have established itself on the Azores. The *Leptaxis* taxa from the Azores are either regarded as distinct species or as subspecies of a single species (Backhuys, 1975). Except for *Leptaxis azorica azorica* (Albers, 1852), the (sub)species are restricted to single islands (Table 1). The two genera differ markedly in their shell shape. Whereas *Leptaxis* has a globular shell (Fig. 2A, B, C; Table 1), the shell of *Helixena sanctaemariae* (Morelet and Drouët, 1857) is high-spined (Fig. 2D). Anatomically, however, *Helixena* is almost indistinguishable from *Leptaxis*. Within the genus *Leptaxis*, two slightly different shell-types have been distinguished: a globular shell-type with an 'obtuse'

apex (*azorica* shell-type; Fig. 2A, B; Table 1) and a more compressed shell-type with a 'pointed' apex (*caldeirarum* shell-type; Fig. 2C; Table 1) (Backhuys, 1975). Interestingly, *Helixena* lives sympatrically with *Leptaxis azorica minor* on Santa Maria, the oldest island of the archipelago, whereas *Leptaxis caldeirarum* lives sympatrically with *L. a. azorica* in the western, younger part of São Miguel (Table 1).

Van Riel *et al.* (2005) suggested a major role of allopatric differentiation via the successive colonization of younger islands, whereas a major role for adaptive evolution was not supported. Interestingly, Van Riel *et al.* (2003) found four distinct lineages within *L. a. azorica* that were compatible with colonization proceeding from the eastern, older islands

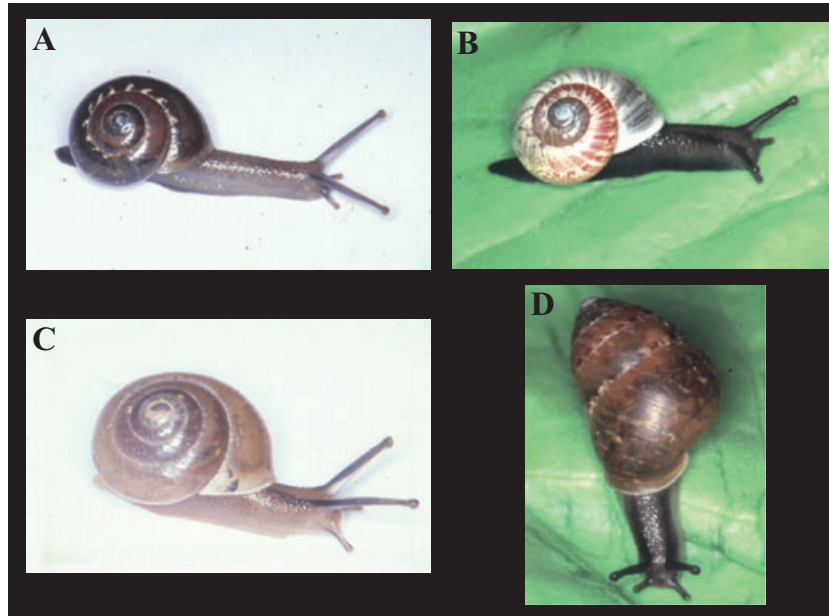

Figure 2. Some representatives of the Azorean Leptaxini: A, *Leptaxis azorica azorica* from São Miguel. B, *Leptaxis azorica minor* from Santa Maria. C, *Leptaxis caldeirarum* from São Miguel. D, *Helixena sanctaemariae* from Santa Maria.

[Santa Maria (*L. a. minor*) and São Miguel (*L. a. azorica*)] to the west (*Leptaxis a. azorica* from Flores). On São Miguel, genetic and morphological differentiation was concordant with the existence of two islands until 0.05 Myr ago.

The phylogeny of the Leptaxini as proposed by Van Riel *et al.* (2005) enables us to make inferences about the circumstances that led to the evolution of shell and genital characters within this group of endemic snails. In the present study, we investigated: (i) to what extent patterns of evolution of shell and genital characters are congruent with each other and with patterns of evolution revealed by molecular markers; (ii) variation in shell and genital morphology within and among the Azorean Leptaxini to evaluate adaptive and non-adaptive scenarios for the observed variation; and (iii) whether the members of this group show species-specific differences in shell and genital morphology and in the morphology of the love dart that may be used for taxonomic purposes.

MATERIAL AND METHODS

SAMPLING AND SAMPLE PREPARATION

Adult individuals (Table 1) of eight species (of which some are undescribed) were collected by hand and stored at -80°C . Because the island history of São Miguel significantly affected the population structure of *L. a. azorica*, and because this species also occurs on the westernmost island (Flores), we will treat *L. a. azorica* as three operational taxonomic

units (OTUs; Table 1) until a formal revision of the genus *Leptaxis* is made (A. M. Frias Martins, K. Jordaens, P. Van Riel & T. Backeljau, unpubl. data). For similar reasons, we will consider *L. a. minor* as a subspecies of *L. azorica*. Animals were removed from their shells and stored in 70% ethanol, which was changed several times.

MORPHOMETRY OF THE SHELL AND THE REPRODUCTIVE ORGANS

A Wild-Heerbrugg micrometer attached to a stereomicroscope (accuracy of 0.01–1 mm, depending on the magnification) was used to take 13 measurements of the genital tract (Fig. 3A) and six of the shell (Fig. 3B). For the shells, we counted the number of whorls to the nearest 0.25 (Fig. 3B) and measured the total height and width, the height of the body whorl, and the height and width of the aperture. For each individual, we measured the length and width of the flagellum, epiphallus, penis, dart sac, vas deferens, the length of the free oviduct, the length of the vagina, and the maximum length of the largest mucus gland diverticulum. Additionally, we counted the number of mucus gland diverticula (when bifurcating, two diverticula were counted). Damaged shells and genitalia were not used in the statistical analyses.

All variables were \log_{10} -transformed and the influence of body size was removed by regressing all measurements of the genital tract against the length of the dart sac. Measurements of the shell were

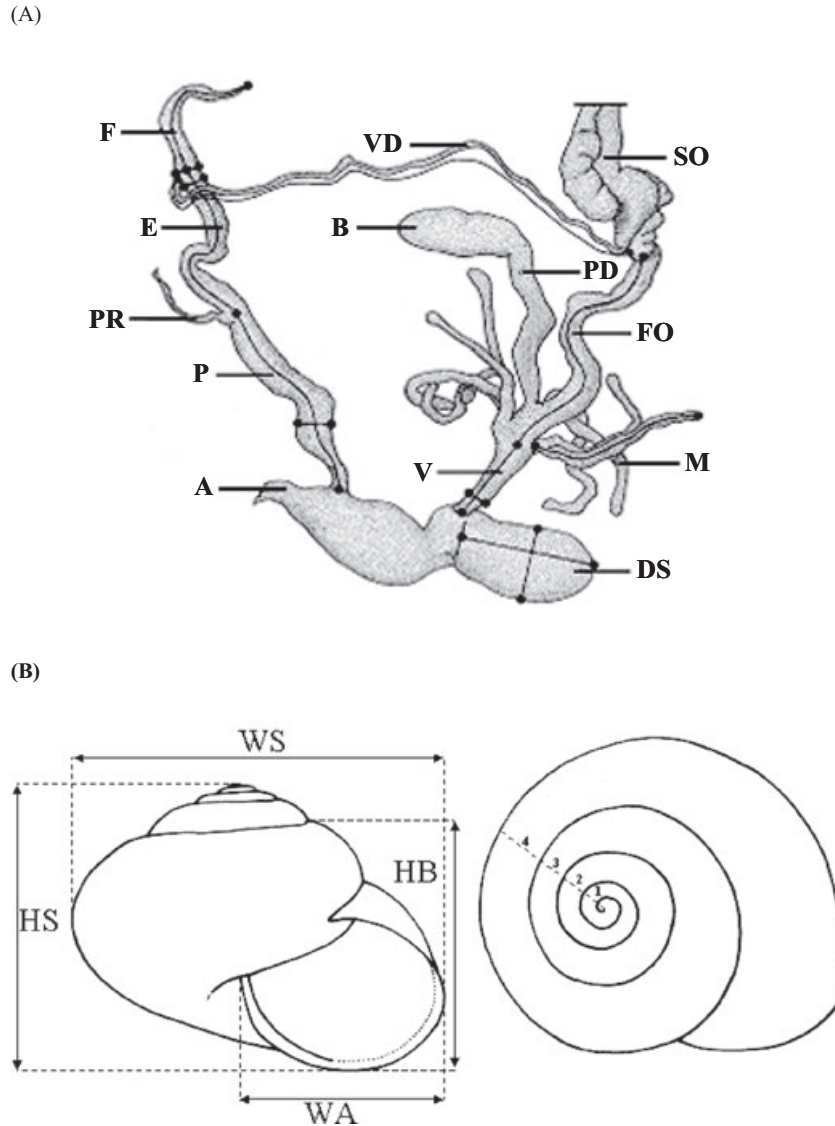

Figure 3. A, camera lucida drawing of the genital tract of *Leptaxis azorica azorica* showing the landmarks of the measured characters (A, genital atrium; B, bursa copulatrix; DS, dart sac; E, epiphallus; F, flagellum; FO, free oviduct; M, mucus gland; P, penis; PD, pedunculus; PR, penis retractor; SO, spermoviduct; V, vagina; VD, vas deferens). B, front and top view of the shell of *L. a. azorica* with indication of the measured characters and method for determining the number of whorls (NW). HB, height of the body whorl; HS, shell height; WA, aperture width; WS, shell width.

regressed against the height of the body whorl. The variables from the shell and genital tract were analysed separately in a principal component analysis (PCA). The first three PCs were subject to an analysis of variance (ANOVA) to test for differences in shell morphology among species and OTUs. Post-hoc comparisons were made using a Scheffé test.

A discriminant analysis (DA) was used to extract discriminant functions by which an individual could be assigned to one of the taxa of the analysis. Group differences were evaluated by computing the proportion of (in)correctly identified individuals in each

group. All analyses were performed using the software packages STATISTICA, version 6.1 (StatSoft Inc.) and SAS, version 6.12 (SAS Institute).

Squared Mahalanobis distances between OTUs of the characters of the reproductive tract were calculated and visualized via nonmetric multidimensional scaling (NMDS) combined with a minimum spanning tree (MST) as implemented by NTSYS, version 1.8 (Rohlf, 1993; Guiller, Bellido & Madec, 1998). A Mantel test was used to compare distances between OTUs based on allozymes and DNA sequence analysis (Van Riel *et al.*, 2005) and the morphology of the

reproductive organs (expressed as the squared Mahalanobis distance).

From two to five individuals of each OTU, the dart sac was dissected out to remove the love dart, which is suitable for taxonomic purposes (Koene & Muratov, 2004). Dart sacs with their dart were put in a saturated sodium hydroxide solution to dissolve the surrounding tissue. This procedure did not affect the morphology of the dart. Subsequently, darts were placed on an aluminium standard, coated with gold and photographed under a Jeol JSM 840 scanning electron microscope.

RESULTS

MORPHOMETRICAL ANALYSIS OF THE SHELL

The first three PCs of the PCA explained 97% of the total variation in shell characters (Table 2). The first PC explained 73% of the total variation and was

Table 2. Factor loadings (correlation coefficients) of traits in the principal component (PC) analysis of shell morphology in species of Leptaxini from the Azores

Character	PC1	PC2	PC3
NW	0.856	-0.361	-0.338
HS	0.854	-0.060	-0.490
WS	-0.347	0.352	0.847
WA	-0.460	0.104	0.857
HA	0.168	-0.965	-0.187
% Variation	73%	16%	8%
% Cumulative variation	73%	89%	97%

The percent of total variation explained by each axis and the cumulative percent of explained variation is also given. NW, number of whorls; HS, height of shell; WS, width of shell; WA, width of the aperture; HA, height of the aperture.

Table 3. Classification matrix of a discriminant analysis on the residuals of five shell characters for all operational taxonomic units (OTUs) within the Azorean Leptaxini

OTU	% Correct	Lae	Law	Laf	Lam	Lc	Lt	Lg	Ld	Lp	Hs
Lae	60	24	11	0	5	0	0	0	0	0	0
Law	64	5	28	1	9	0	0	0	1	0	0
Laf	10	5	4	2	7	0	0	0	3	0	0
Lam	54	1	8	3	14	0	0	0	0	0	0
Lc	42	0	0	1	0	13	13	0	4	0	0
Lt	89	0	0	0	0	4	55	0	3	0	0
Lg	0	0	0	0	0	0	5	0	0	0	0
Ld	59	0	0	0	0	3	6	0	13	0	0
Lp	0	0	2	0	0	0	0	0	5	0	0
Hs	100	0	0	0	0	0	0	0	0	0	156
Total	73.7	35	53	7	35	20	79	0	29	0	156

strongly, positively correlated with the number of whorls and shell height. The ANOVA revealed significant differences among the species ($F_{7,411} = 231.5$, $P < 0.001$). *Helixena sanctaemariae* has a higher shell and a higher number of whorls than the other species (Scheffé test: $P < 0.001$ in all cases). *Leptaxis a. azorica* and *L. a. minor* are very similar and have a relatively higher shell and a higher number of whorls than the other *Leptaxis* species (Scheffé test: $P < 0.001$ in all cases). PC2 explained 16% of the total variation and was strongly, negatively related with the height of the aperture. Species differed significantly in their aperture height ($F_{7,411} = 12.75$; $P < 0.001$). *Leptaxis a. azorica* has a significantly larger aperture height than *L. a. minor* (Scheffé test: $P < 0.001$). The aperture height of *L. a. minor* is also significantly smaller than that of *L. drouetiana*, *Leptaxis* sp. from Graciosa and *H. sanctaemariae* (Scheffé test: $P < 0.001$ in all cases). PC3 explained another 8% of the total variation and was strongly positively correlated with the width of the shell and of the aperture. Species differed significantly in these characters ($F_{7,411} = 233.49$; $P < 0.001$). *Leptaxis a. azorica* and *L. a. minor* were very similar but relatively more slender than the other species (Scheffé test: $P < 0.001$ in all cases). In addition, *L. caldeirarum* and *L. drouetiana* were more slender compared to *H. sanctaemariae* (Scheffé test: $P < 0.001$ in both cases).

The DA revealed that 73.7% of the shells could be classified correctly on the basis of their morphology (Fig. 4A; Table 3). Shells with an *azorica* shell-type were never classified as a *caldeirarum* shell-type (except four as *L. drouetiana*) and vice versa (except two of *Leptaxis* sp. from Pico as *L. a. azorica* from western São Miguel and one of *L. caldeirarum* as *L. a. azorica* from Flores) (Table 3). Within the OTUs of the *azorica* shell-type, 52% of the shells were missclassified. Especially shells of *L. a. azorica* from Flores were missclassified. Similarly, within the *cal-*

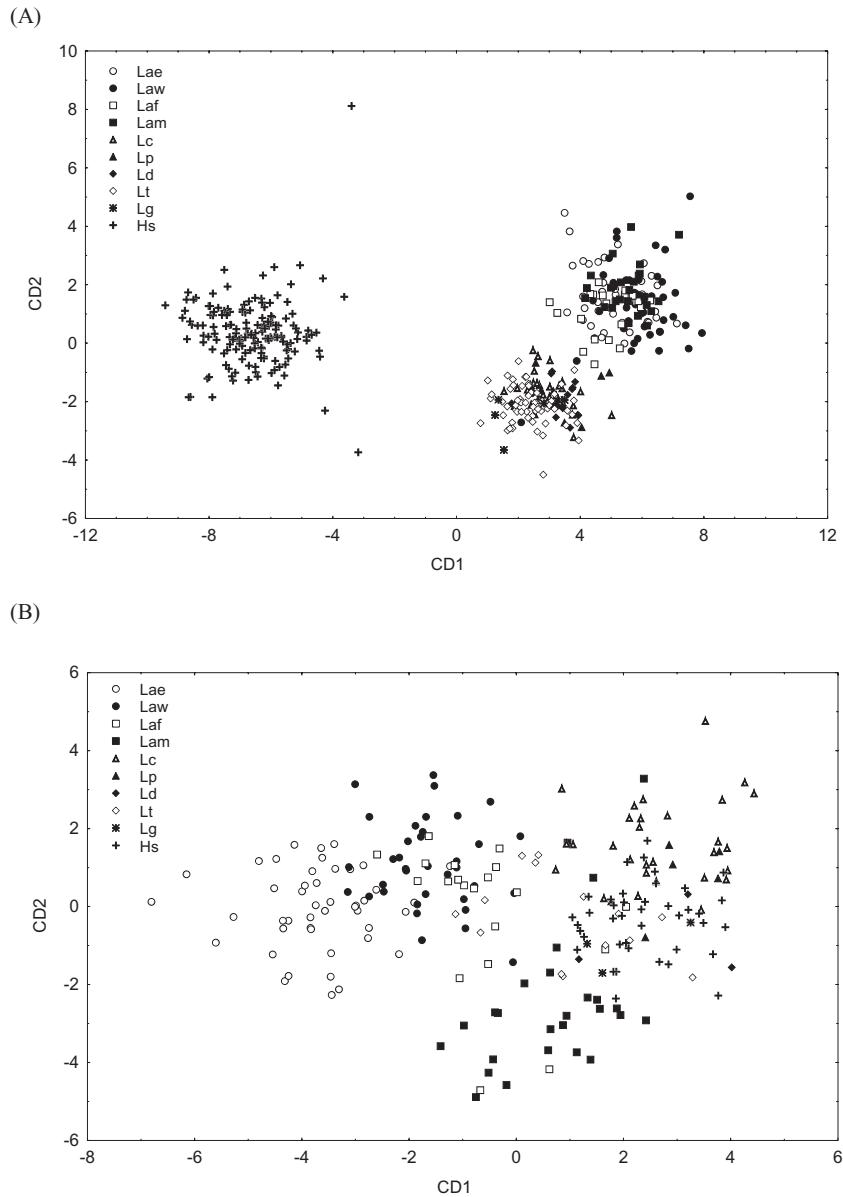

Figure 4. Two-dimensional scatter plot of the first two discriminant functions based on individual factor scores from a principal component analysis of the shell characters (A) and the genital characters (B). For the full names of the operational taxonomic units, see Table 1.

deirarum shell-type, there were also a high number of shells (38%) that were misclassified. Finally, all shells of *H. sanctaemariae* were classified correctly (Table 3).

In summary, the results of the morphometrical analysis of the shell characters showed, in addition to the obvious distinction of *H. sanctaemariae* with its high-spined shell, that: (i) the shell of *L. a. azorica* and *L. a. minor* is low-spined and globose (*azorica* shell-type); (ii) the shell of the other *Leptaxis* species is flatter than that of the *azorica* shell-type (*caldei-*

rarum shell-type); and (iii) differences among species within shell-types are absent or very subtle.

MORPHOMETRICAL ANALYSIS OF THE REPRODUCTIVE ORGANS

The first three PCs of the PCA explained 77% of the total variation in genital characters (Table 4). The first PC explained 46% of the total variation and was strongly, positively correlated with the length characters, and negatively with the width characters, of

the male genital parts and the flagellum (Table 4). The ANOVA revealed significant differences among the species ($F_{7,220} = 23.17$; $P < 0.0001$). *Leptaxis a. azorica* had significantly smaller male reproductive organs than *L. a. minor*, *L. caldeirarum*, and *H. sanctaemariae* (Scheffé test: $P < 0.0001$). The male

Table 4. Factor loadings (correlation coefficients) of traits in the principal component (PC) analysis of genital morphology in species of Leptaxini from the Azores

Character	PC1	PC2	PC3
MM	0.301	-0.802	0.045
NM	-0.133	-0.158	-0.891
LF	0.672	-0.562	-0.054
LE	0.831	-0.170	-0.213
LP	0.822	-0.328	-0.151
LFO	0.203	-0.788	0.274
LV	-0.262	-0.475	0.324
LVD	0.854	-0.361	-0.064
WF	-0.889	-0.319	-0.029
WE	-0.863	-0.384	-0.020
WP	-0.784	-0.458	-0.082
WDS	-0.546	-0.653	-0.103
WVD	-0.891	-0.026	-0.139
% Variation	46	23	8
% Cumulative variation	46	69	77

Percent of total variation explained by each axis and the total percent of explained variation is also given. MM, maximum length of the largest mucus gland diverticulum; NM, number of mucus gland diverticula; LF, length of the flagellum; LE, length of the epiphallus; LP, length of the penis; LFO, length of the free oviduct; LV, length of the vagina; LVD, length of the vas deferens; WF, width of the flagellum; WE, width of the epiphallus; WP, width of the penis; WDS, width of the dart sac; WVD, width of the vas deferens.

Table 5. Classification matrix of a discriminant analysis on 13 genital characters for all operational taxonomic units (OTUs) within the Azorean Leptaxini

OTU	% correct	Lae	Law	Laf	Lam	Lc	Lt	Lg	Ld	Lp	Hs
Lae	96	43	2	0	0	0	0	0	0	0	0
Law	78	5	28	1	1	0	0	0	0	0	1
Laf	90	0	1	18	0	0	1	0	0	0	0
Lam	96	0	0	0	25	1	0	0	0	0	0
Lc	83	0	0	0	0	25	1	1	0	0	3
Lt	64	0	0	0	0	4	9	0	0	0	1
Lg	100	0	0	0	0	0	0	3	0	0	0
Ld	67	0	0	0	0	0	0	0	2	1	0
Lp	100	0	0	0	0	0	0	0	0	5	0
Hs	93	0	0	0	1	2	0	0	0	0	43
Total	88.2	48	31	19	27	32	11	4	2	6	48

genitalia of *L. terceirana* were also significantly smaller than those of *L. a. minor* (Scheffé test: $P = 0.01$) and *H. sanctaemariae* (Scheffé test: $P = 0.001$). PC2 explained 23% of the total variation and was strongly, negatively correlated with the length of the free oviduct, the width of the dart sac, and the length of the largest mucus gland diverticulum (Table 4). ANOVA analysis revealed significant differences among the species ($F_{7,220} = 11.1$, $P < 0.0001$). The Scheffé tests showed that *L. a. azorica* had a significantly shorter free oviduct and more slender dart sac than *L. a. minor*, *L. caldeirarum*, *L. terceirana*, and *H. sanctaemariae* (all $P < 0.001$). Finally, PC3 explained 8% of the total variation and was strongly, negatively correlated with the number of mucous glands. ANOVA analysis revealed significant differences among the species ($F_{7,220} = 28.13$, $P < 0.001$). The Scheffé test showed significant differences among species with a high mean number of mucous glands [*L. caldeirarum* (mean \pm standard error): 9.6 ± 0.3 ; *Leptaxis* sp. from Pico: 9.2 ± 0.4] from species with an intermediate mean number of mucous glands (*L. a. azorica*: 8.1 ± 0.1 ; *L. drouetiana*: 7.3 ± 0.3 ; *H. sanctaemariae*: 7.8 ± 0.1) and from species with a low mean number of mucous glands (*L. a. minor*: 6.7 ± 0.2 ; *L. terceirana*: 6.6 ± 0.2 ; *Leptaxis* sp. from Graciosa: 6.7 ± 0.3).

The DA showed that 88.2% of the individuals were correctly classified (Fig. 4B; Table 5). Two incorrectly classified individuals with an *azorica* shell-type were classified within an OTU of the *caldeirarum* shell-type and a third individual was classified as *H. sanctaemariae*. Eleven out of 55 individuals with a *caldeirarum* shell-type were incorrectly classified. Four were classified as *L. caldeirarum* and another four as *H. sanctaemariae*. None of the incorrectly classified shells of the *caldeirarum* shell-type was

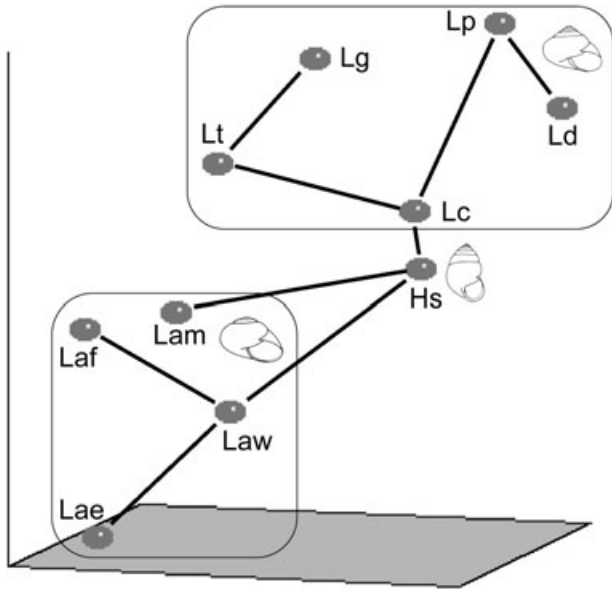

Figure 5. Two-dimensional plot of the ten operational taxonomic units (OTUs) of the Azorean Leptaxini via non-metric multidimensional scaling (NMDS) combined with a minimum spanning tree (MST) based on the squared Mahalanobis distances calculated from measurements of the genital tract. For the full names of the OTUs, see Table 1. OTUs with the same shell-type are grouped in rectangles. Note that the grouping of *Leptaxis azorica minor* with *Leptaxis azorica azorica* is artificial and that this species shows stronger affinities with *Helixena sanctaemariae*.

classified into OTUs of the *azorica* shell-type. Two individuals of *H. sanctaemariae* were classified as *L. caldeirarum* and one as *L. a. minor*.

The results of the NMDS/MST analysis are given in Figure 5. The OTUs with the *caldeirarum* shell-type form a distinct group and were most closely related to *H. sanctaemariae*. *Leptaxis a. azorica* and *L. a. minor* (*azorica* shell-type) also constitute a distinct group. However, the superimposed MST indicated a higher similarity of *L. a. minor* with *H. sanctaemariae* than with the other OTUs of the *azorica* shell-type. The Mantel test showed no significant relationship between the morphological distance among OTUs (estimated from the morphometrical differences in the reproductive organs) and the genetic distance calculated from allozyme data ($r = 0.17$, $P = 0.07$). However, there was a significant relationship between the morphological distance among OTUs and the genetic distance calculated from DNA sequence data ($r = 0.49$, $P = 0.004$).

QUALITATIVE OBSERVATIONS OF THE LOVE DART

The love dart of *L. a. azorica* is characterized by short blades and a slightly curved shaft (Fig. 6A). It differs conspicuously from the love dart of all other OTUs, which have longer blades and a more curved shaft. The OTUs of the *caldeirarum* shell-type (Fig. 6C) share the same love dart type, which is very similar to that of *H. sanctaemariae* (Fig. 6D) and *L. a. minor* (Fig. 6B). However, the blades of the love dart of *L. a.*

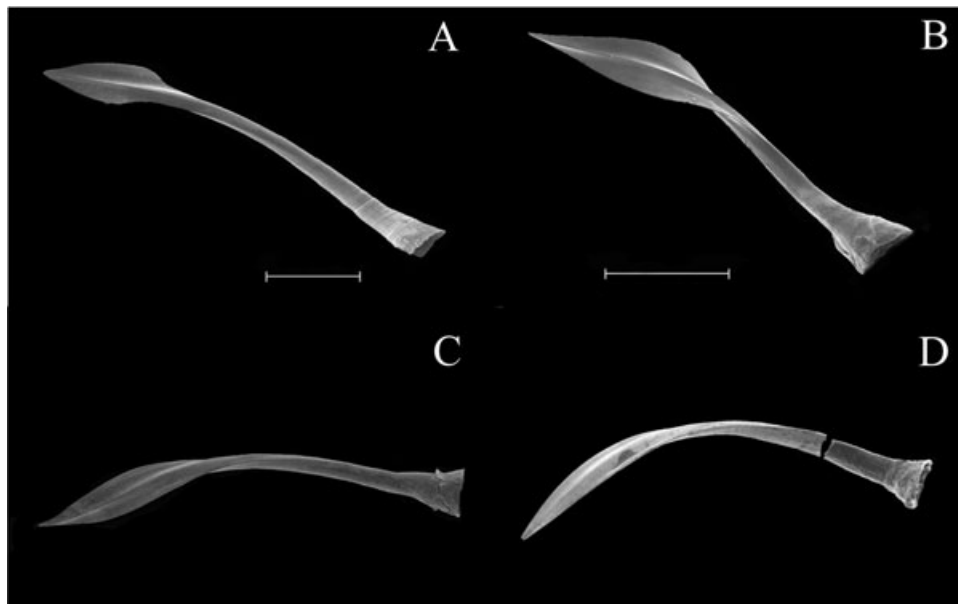

Figure 6. The love dart of *Leptaxis azorica azorica* (A), *Leptaxis azorica minor* (B), *Leptaxis caldeirarum* (C) and *Helixena sanctaemariae* (D). Scale bar = 1 mm and is the same for (A, C, D).

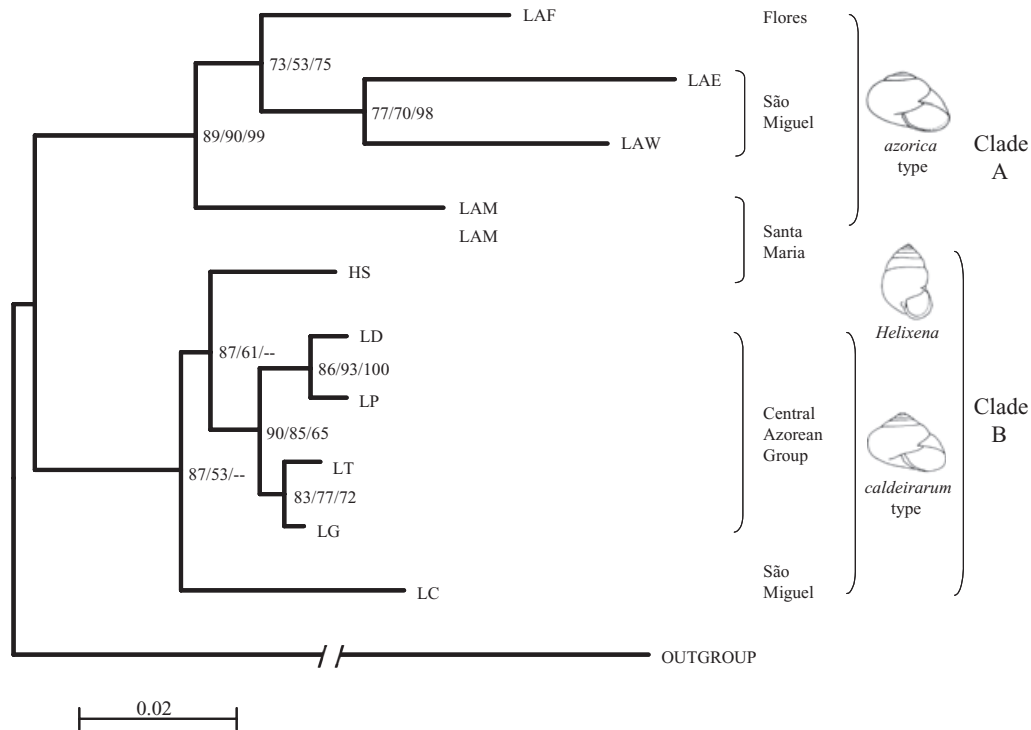

Figure 7. Optimal topology obtained via maximum likelihood analysis of a concatenated data set with cytochrome oxidase I and internal transcribed spacer 1, for all operational taxonomic units of the Azorean Leptaxini (for abbreviations, see Table 1). Terminal branch to outgroup scaled to 1 : 5. Bootstrap [maximum parsimony (MP); maximum likelihood (ML); 1000 replicates] support values and Bayesian posterior probabilities (BA; 10 000 trees sampled) are given for nodes supported > 50% (MP/ML/BA).

minor extend over a larger area on the shaft, whereas the love dart of *H. sanctaemariae* is more strongly curved and has narrow blades.

In summary, the results of the morphometrical analysis of the genital characters showed that species differ in: (i) the relative size of the male and female reproductive organs; (ii) the mean number of mucous glands; (iii) the size and shape of the love dart; and additionally (iv) there is a strong congruence between the shell-type and the morphology of the reproductive organs, even though *L. a. minor* shows a higher similarity with *H. sanctaemariae*.

DISCUSSION

TAXONOMIC IMPLICATIONS

Molluscan shells are well-known for their highly adaptive nature (Goodfriend, 1986; Chiba, 1996, 2004) and this may result in an incongruence between species taxonomy and phylogenetic relationships (Parmakelis *et al.*, 2003; Alonso *et al.*, 2006). Similarly, parallel evolution results in complexes of associated characters that have arisen through natural selection so that shell-types do not form monophyletic groups (Johnson, Murray & Clarke, 2000). By con-

trast, differentiation among the Azorean Leptaxini in shell morphology is congruent with evolutionary patterns inferred from molecular data (Van Riel *et al.*, 2005; Fig. 7). The morphological analysis of the shell characters of the Azorean Leptaxini revealed three distinct shell-types: a *H. sanctaemariae*, an *azorica*, and a *caldeirarum* shell-type (Table 1). Differentiation in the genital anatomy among the three shell-types and among species appears to be more subtle.

The distinctiveness of the OTUs of *L. a. azorica* by the smaller size of the genitalia and the shape of the love-dart supports its monophyly (Van Riel *et al.*, 2005). However, the genital anatomy of *L. a. minor* appears more similar to that of *H. sanctaemariae* than to that of the OTUs from the *azorica* group, which is not supportive for the monophyly of the *azorica* shell-type (clade A of Van Riel *et al.*, 2005) (Fig. 7). The congruence of morphological and molecular differentiation was already demonstrated among the three OTUs within *L. a. azorica* on different islands (Flores, West, and East São Miguel) (Van Riel *et al.*, 2003, 2005). The monophyly of the *caldeirarum* shell-type was supported by the morphometrical analyses, with *L. caldeirarum* at the basis of the clade. Although *H. sanctaemariae* is anatomically

clearly distinct from the *caldeirarum*-group (e.g. by its love-dart), it is very similar to *L. caldeirarum* according to the morphometrical analysis, which suggests a basal position within the *caldeirarum* clade (i.e. clade B of Van Riel *et al.*, 2005) (Fig. 7). Finally, the molecular data (Van Riel *et al.*, 2003, 2005) and our morphological data show that the OTUs within the *azorica* and within the *caldeirarum* shell-type may represent distinct species. A formal (re)description of the Azorean Leptaxini will be presented elsewhere (A. M. Frias Martins, K. Jordaens, P. Van Riel & T. Backeljau, unpubl. data).

Interestingly, most variation in the genital characters was observed in the male copulatory organs and follows the general evolutionary trend in animals with internal fertilization (Arnqvist, 1998). Reproductive isolation (partial or complete) can be achieved through small differences in the male copulatory organs that are believed to result from sexual selection or sperm competition (Koene & Schulenburg, 2005). Strong isolation and genetic drift may enhance the divergence of characters involved in sexual selection or sperm competition, which may become suitable taxonomic markers. Good examples within the Leptaxinae appears to comprise the size and shape of the love-dart (Fig. 6) (see also Koene & Muratov, 2004) and the number of mucous glands which show low variation within, but high variation among, species. Unfortunately, the absence of co-occurring species of the same shell-type on the Azores (apart from *L. a. azorica* from western and eastern São Miguel that co-occur in the central part of the island) prevents the study of reproductive incompatibility or isolation under natural conditions.

ADAPTIVE VERSUS NON-ADAPTIVE DIFFERENTIATION

Shells of land snails are subject to many selective pressures that are related to environmental and ecological conditions (Cain & Cowie, 1978; Goodfriend, 1986; Cameron & Cook, 1989) and many species interact competitively. Shells are thus highly susceptible for adaptive changes (i.e. adaptive radiation *sensu* Davison, 2002) but there are several examples of rapid proliferation of species accompanied by negligible or infrequent ecological differentiation (i.e. non-adaptive radiation *sensu* Gittenberger, 1991). Intra-island speciation in snails is common on volcanic islands (Solem, 1990); it may be frequently non-adaptive in part, and driven by volcanic disturbances and sharp topographical barriers (Cook, 1996; Cameron & Cook, 2001).

Geographical isolation appears to be an important mechanism underlying morphological and molecular differentiation in the Azorean Leptaxini (Van Riel *et al.*, 2003, 2005) instead of adaptive radiation

through ecological differentiation. First, there was a significant relation between the morphological distance among OTUs calculated from characters of the reproductive organs and the genetic distance calculated from DNA sequence data (but not when genetic distance was calculated using allozyme data), suggesting that long term isolation and genetic drift seem important. Second, the morphological differences between *L. a. azorica* and *L. caldeirarum* that live sympatrically on São Miguel are presumed to result from separate colonization events (Van Riel *et al.*, 2005). Third, a sympatric origin on the oldest island (Santa Maria, 8 Myr) for *L. a. minor* and *H. sanctaemariae* could not be excluded (Van Riel *et al.*, 2005) but the morphological divergence in the reproductive organs is comparable to that between other species that occur on different islands and demonstrate a similar genetical divergence (results not shown). Even though the species have an overlapping, but asymmetric, distribution on Santa Maria (which may indicate that they differ in their ecological niche), essential data on the ecology (e.g. habitat use, food preferences, etc.) of the species are lacking. Thus, it remains speculative to consider the aberrant difference in shell shape but a close anatomical relationship as an example of rapid changes or nonhierarchical relationships that characterize sympatric speciation.

Remarkably, the geological history of São Miguel is reflected in the genetic and morphological (both conchological and genital-anatomical) differentiation of populations of *L. a. azorica* from the western and eastern part of the island. A similar situation is observed on the oldest of the Madeiran Islands (Porto Santo), where several phases of high sea level would have reduced the connection between the eastern and western parts of the island, which may explain the differentiation within several taxa of land snails such as *Caseolus* and *Discula* (Goodfriend *et al.*, 1995; Cameron, Cook & Hallows, 1996). Apart from a major role of allopatric speciation in both archipelagos, differentiation at the specific level as observed on Santa Maria between *L. a. minor* and *H. sanctaemariae* also occurs in the Leptaxinae of Madeira, where *L. vulcanica* coexists with *Leptaxis leonina* on the island of Deserta Grande (Cameron *et al.*, 1996).

ACKNOWLEDGEMENTS

This work was supported by the projects PRAXIS I and II, as well as by OSTC projects MO/36/003 and MO/36/008 to T.B. We thank Harry Van Paesschen and Lobke Dillen for their help with the illustrations and two anonymous referees for their comments which improved the manuscript considerably. K.J. is

a Postdoctoral Fellow of the Fund for Scientific Research – Flanders (F.W.O.). P.V.R. was funded by an IWT scholarship.

REFERENCES

- Alonso MR, Goodacre SL, Emerson BE, Ibáñez M, Hutterer R, Groh K. 2006.** Canarian land snail diversity: conflict between anatomical and molecular data on the phylogenetic placement of five new species of *Napaeus* (Gastropoda, Pulmonata, Enidae). *Biological Journal of the Linnean Society* **89**: 169–187.
- Arnqvist G. 1998.** Comparative evidence for the evolution of genitalia by sexual selection. *Nature* **393**: 784–786.
- Backhuys W. 1975.** *Zoogeography and taxonomy of the land, fresh-water molluscs of the Azores*. Amsterdam: Backhuys and Meesters.
- Cain AJ, Cowie RH. 1978.** Activity of different species of land snail on surfaces of different inclinations. *Journal of Conchology* **29**: 267–272.
- Cameron RAD, Cook L. 1989.** Shell size and shape in Madeiran land snails: do niches remain unfilled? *Biological Journal of the Linnean Society* **36**: 79–96.
- Cameron RAD, Cook L. 2001.** Madeiran snails: faunal differentiation on a small island. *Journal of Molluscan Studies* **67**: 257–267.
- Cameron RAD, Cook LM, Hallows JD. 1996.** Land snails on Porto Santo: adaptive and non-adaptive radiation. *Philosophical Transactions of the Royal Society of London B* **351**: 309–327.
- Chiba S. 1996.** Ecological and morphological diversification within single species and character displacement in *Mandarina*, endemic land snails of the Bonin Islands. *Journal of Evolutionary Biology* **9**: 277–291.
- Chiba S. 2004.** Ecological and morphological patterns in communities of land snails of the genus *Mandarina* from the Bonin Islands. *Journal of Evolutionary Biology* **17**: 131–143.
- Cook LM. 1996.** Habitat, isolation and the evolution of Madeiran landsnails. *Biological Journal of the Linnean Society* **59**: 457–470.
- Davison A. 2002.** Land snails as a model to understand the role of history and selection in the origins of biodiversity. *Population Ecology* **44**: 129–136.
- Gittenberger E. 1991.** What about nonadaptive evolution? *Biological Journal of the Linnean Society* **43**: 263–272.
- Goodfriend GA. 1986.** Variation in land-snail shell form and size and its cause: a review. *Systematic Zoology* **35**: 204–223.
- Goodfriend GA, Cameron RAD, Cook LM, Courty M-A, Fedoroff N, Kaufman A, Livett E, Tallis J. 1995.** Quaternary eolianite sequence of Madeira: stratigraphy, chronology, and paleoenvironmental interpretation. *Palaeogeography, Palaeoclimatology, Palaeoecology* **120**: 195–234.
- Guiller A, Bellido A, Madec L. 1998.** Genetic distances and ordination: the land snail *Helix aspersa* in North Africa as a test case. *Systematic Biology* **47**: 208–227.
- Johnson CL, Wijbrans JR, Constable CG, Gee J, Staudigel H, Tauxe L, Forjaz VH, Salgueiro M. 1998.** ⁴⁰Ar/³⁹Ar ages and paleomagnetism of São Miguel lavas, Azores. *Earth and Planetary Science Letters* **160**: 637–649.
- Johnson MS, Murray J, Clarke B. 2000.** Parallel evolution in Marquesan partulid land snails. *Biological Journal of the Linnean Society* **68**: 577–598.
- Koene JM, Muratov IV. 2004.** A revision of the reproductive morphology of three *Leptaxis* species (Gastropoda, Pulmonata, Hygromiidae) and its implications on dart evolution. *Malacologia* **46**: 73–78.
- Koene JM, Schulenburg H. 2005.** Shooting darts: co-evolution and counter-adaptation in hermaphroditic animals. *BMC Evolutionary Biology* **5**: 25.
- Parmakelis A, Spanos E, Papagiannakis G, Louis C, Mylonas M. 2003.** Mitochondrial DNA phylogeny and morphological diversity in the genus *Mastus* (Beck, 1837): a study in a recent (Holocene) island group (Koufonisi, south-east Crete). *Biological Journal of the Linnean Society* **78**: 383–399.
- Rohlf FJ. 1993.** *NTSYS-pc*, Version 1.80. Setauket: Applied Biostatistics Inc.
- Solem A. 1990.** Limitations of equilibrium theory in relation to land snails. *Atti dei Convegni Lincei* **85**: 97–116.
- Van Riel P, Jordaens K, Van Houtte N, Frias Martins AM, Verhagen R, Backeljau T. 2005.** Molecular systematics of the endemic Leptaxini (Gastropoda: Pulmonata) on the Azores islands. *Molecular Phylogenetics and Evolution* **37**: 132–143.
- Van Riel P, Jordaens K, Verhagen R, Frias Martins AM, Backeljau T. 2003.** Genetic differentiation reflects geological history in the Azorean land snail, *Leptaxis azorica*. *Heredity* **91**: 239–247.